



MIZAR RY4

4" Eyeball Recessed Downlight

Selectable 5 CCT 2000K to 4000K

Specification Sheet

Project Name :

Location :

Quantity :

Date :

Note :

Feature

RY4 features selectable 5 CCT ranging from 2000K to 4000K, enabling you to bring the best mood for both commercial and residential applications. The stylish narrow trim design blends the fixture unobtrusively into the ceiling, and the deep regressed lens eliminates glare. The CRI>90 LED provides the most natural and comfortable light source.

Ordering Code

- W - White
- B - Black

Modes

Selectable 5 CCT mode:

- 2000K, CRI>90
- 2500K, CRI>90
- 3000K, CRI>90
- 3500K, CRI>90
- 4000K, CRI>90

Specification

- Application: Ceiling Recessed Mount
- DCOB (Driver on COB) light engine
- Ø 4¼ inch cut out hole
- Ø 2 inch aperture
- Aiming: Rotate 360°, Tilt ±20°
- Powder coated spun aluminum trim
- Optics: 36° TIR lens
15°, 24°, 45° available for special orders
- Clip designed for max. 1" thick ceiling
- Source lumen: 1100lm@10W
- Source lumens per watt: 110
- Delivered lumen: 672lm@10W
- Lumen Maintenance: 70% @60,000 hrs
- Approved Location: IP20, Dry
- Certification: cETLus
- Five year limited warranty, consult website for detail: vyvydlighting.ca/legal

Dimensions

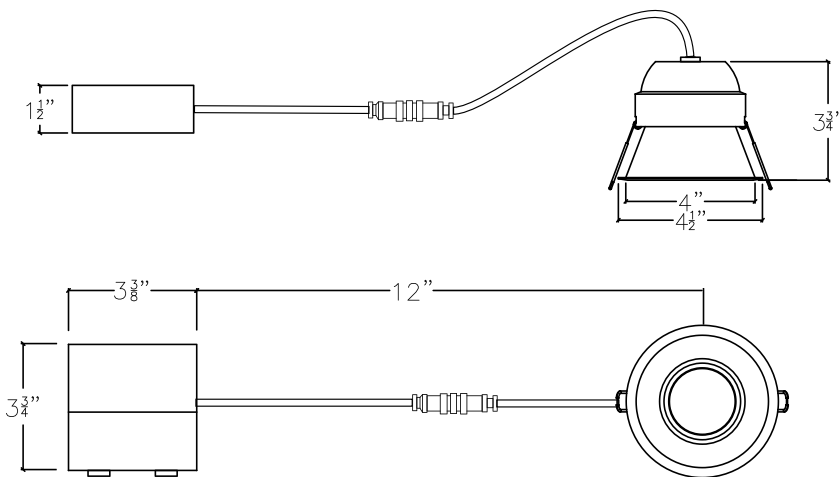

MIZAR RY4 4" Eyeball Recessed Downlight

Colorimetric Data (TM30-15)

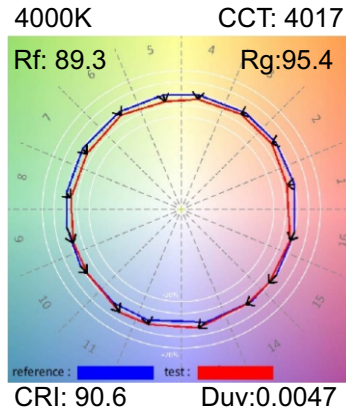
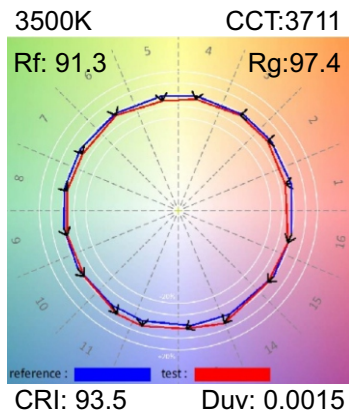
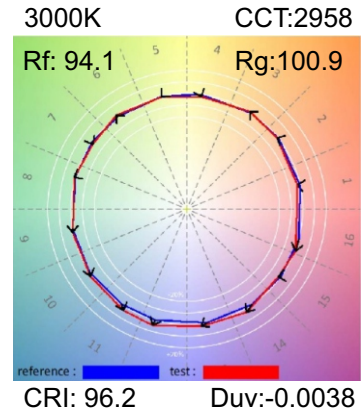
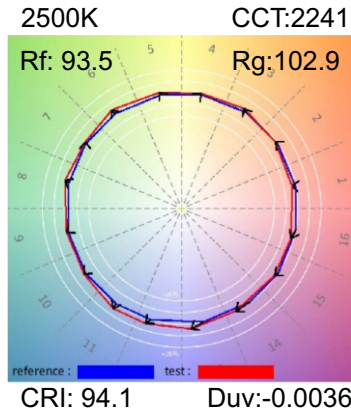
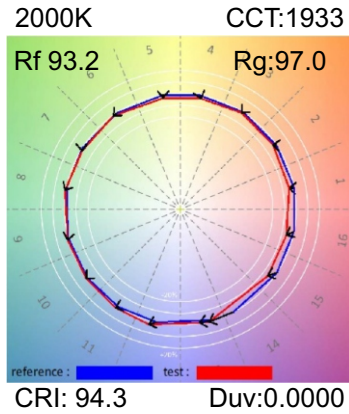

Photometric Data

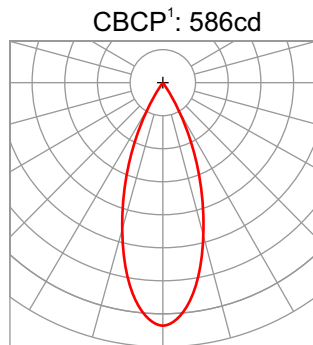

D(ft)	fc	Lux	672 lm	Ø (in.)
3	128	1367	36° ²	20
6	32	342		40
9	14	152		59
12	8	52		79
15	5	55		99

¹ CBCP: Centre Beam Candlepower

² FWHM: Full Width Half Maximum Angle