



MIZAR R905

Integrated LED Lighting Fixture
Fixed Low Glare

Product Description

Extra wide baffle trim of R905 recessed LED lighting fixture minimizes reflective glare from the baffle, and blends unobtrusively in the ceiling. The combination M2 high power light engine, the stylish die-cast trim and the reliable driver makes this recessed lighting fixture an ideal choice to meet all functional and aesthetic requirements of residential and commercial applications.

Order Information

Example: R905-9-25T-VN-B-E-43HC

Model R905	Power	COB	Beam Angle
Integrated Recessed LED Engine Fixture	9 - 9W 12 - 12W	25T - 2500K, CRI>95 27T - 2700K, CRI>95 30T - 3000K, CRI>95 35T - 3500K, CRI>95 30C - 3000K, CRI>90 40C - 4000K, CRI>90 DW - Dim to Warm 2200K-3000K	VN - Very Narrow Spot NS - Narrow Spot SP - Spot FD - Flood WF - Wide Flood
Trim Color	Dimming	Accessories	
B - Black W - White	E - ELV/Triac Dimming V - 0-10V Dimming	43HC - 43mm. honeycomb louvre RP - Rough-in Plate	

* 9° is available only in 9W

Project Name :
Location :
Quantity :
Date :
Note :



Features

LED Light Source:

Available in a wide range of colour temperatures with high color fidelity and gamut to bring out vivid colors.

Optics: TIR lens collimate light into precisely controlled beam shapes ranging from 13° narrow spot to 60° wide flood.

Driver:

Flicker free TRIAC or 0-10V silicon filled driver for maximum lifespan.

Heat Sink:

Cold forged engine grade pin fin aluminum heat sink provides optimal heat Management in a small package.

Specification

CCT: 2500K/2700K/3000K/3500K/4000K
CRI: >90 / >95
Tilt: None, Fixed
Dimming: ELV/0-10V Dimming
Total lumen output max: 1300 lm @ 12W
Delivered lumen max: 937 lm @ 12W
Power consumption: 9W / 12W
Power factor: >0.9
Power Driver Type: Constant Current
Input voltage: 120V, 60Hz
Approved locations: IP20, Dry
Lumen maintenance: 70% @ 60,000 Hrs
THD <20%
Certification: cETLus
Warranty: 5 years limited warranty

Dimensions
Cut Out: 3½ inch
Outer Diameter: 3.5 inch
Ceiling Clearance Required: 5.2 inch



Consult website for detail:
www.vyvydlighting.ca/warranty

R905 Integrated LED Recessed Light

Dimensions

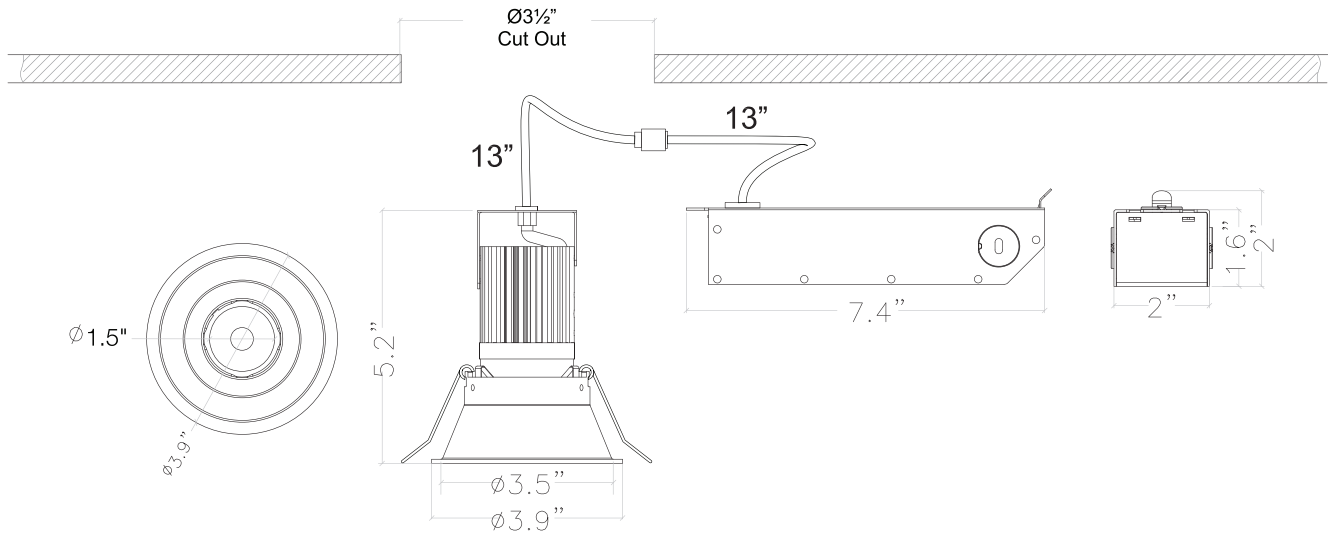

Colorimetric Data (TM30-15)

Realist Series: Full gamut light source that mimics the colour rendering property of halogen lamps.

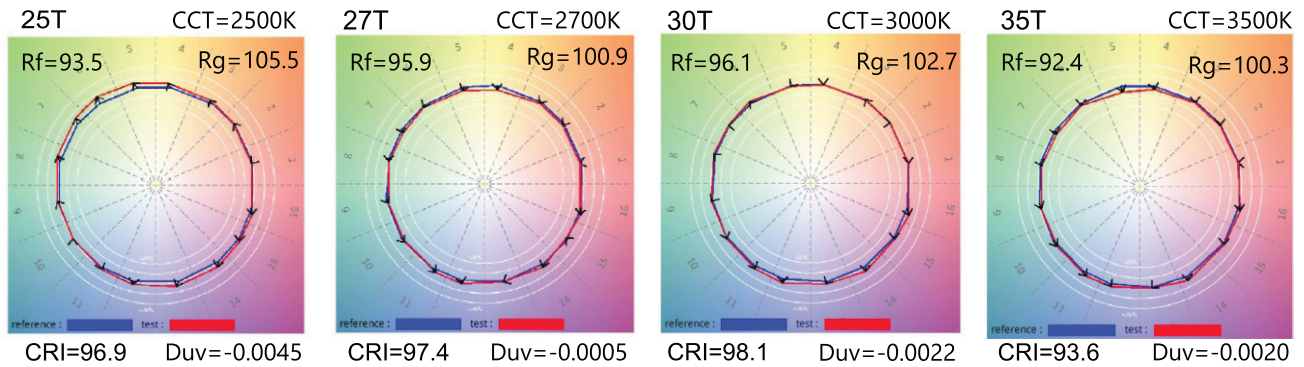

Impressionist Series: Colour enhancing light source that renders over-saturated colours

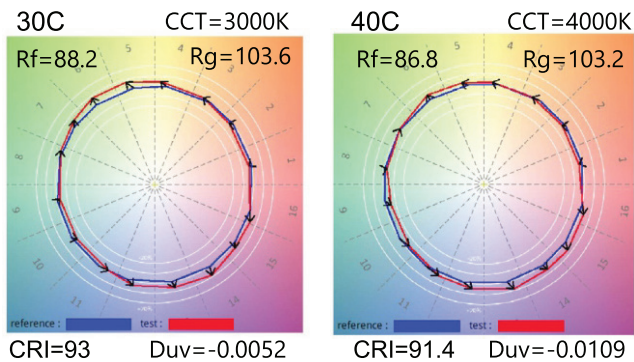

R905 Integrated LED Recessed Light

Photometric Data

9W

9W VN-Very Narrow Spot, FWHM²=9°

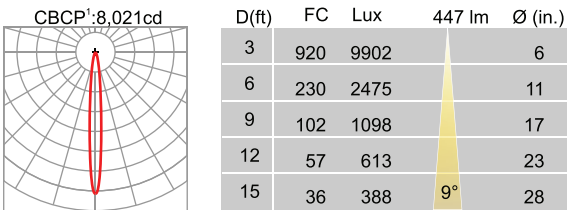

9W SP-Spot, FWHM²=20°

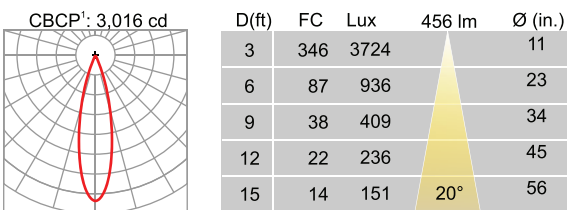

9W WF-Wide Flood, FWHM²=56°

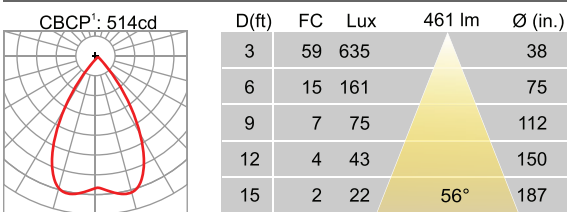

12W

12W NS- Narrow Spot, FWHM²=13°

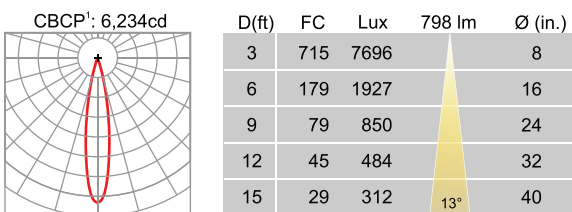

12W FD-Flood, FWHM²=43°

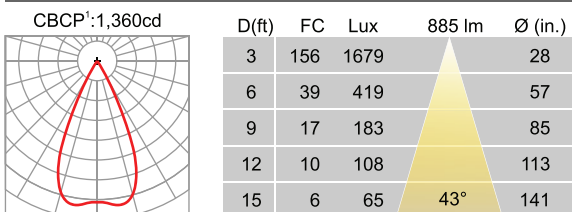

Data shown is measured for 30C light source. Multiply CBCP, FC and Lux by the following adjustment factors for other light sources

Light Source	25C	27T	30T	35T	30C	40C
Adjustment factors	0.88	0.92	0.98	1.02	1.00	1.05

9W NS-Narrow Spot, FWHM²=13°

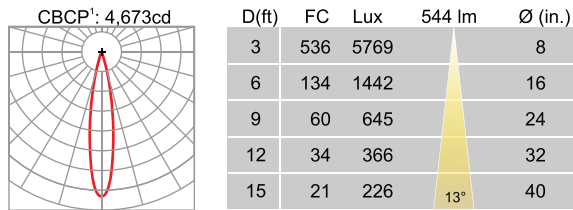

9W FD-Flood, FWHM²=43°

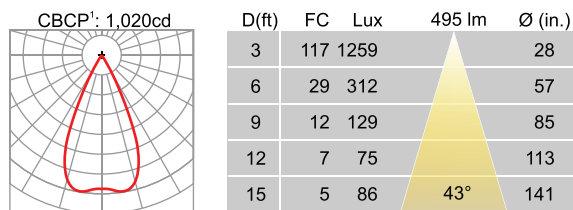

12W SP- Spot, FWHM²=20°

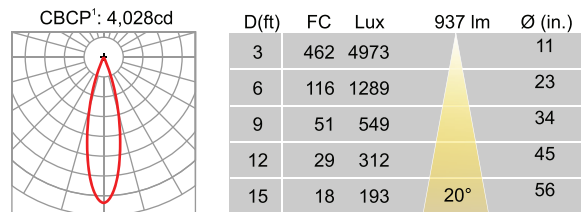

12W WF-Wide Flood, FWHM²=56°

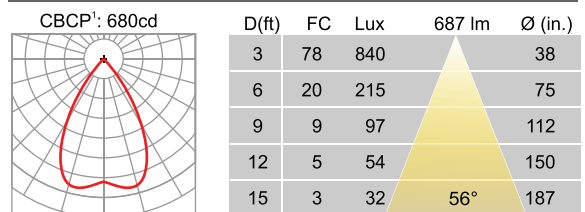

¹ CBCP: Centre Beam Candlepower

² FWHM: Full Width Half Maxium Angle