



# Canister Small T634

Integrated D-COB LED Track Light  
ELV Dimmable | 1000 lumen | 10W

## Specification Sheet

Project Name :
Location :
Quantity :
Date :
Note :

### Product Description

T634 LED track head features a minimalist canister design to meet the functional and the aesthetic requirements for accent and task lighting. The compact size is unobtrusive and easily blends in with the ceilings. The beam spots are even in the center and smoothly fades to a soft edge, with minimal glare.

### Order Information

Example: T634-10-27K-NS-H-B-HC

Model <b>T634</b>	Power <b>10</b>	Colour Quality	Beam Angle	Adaptor
Canister Track Light	<b>10</b> - 10W	<b>27K</b> - 2700K, CRI>90 <b>30K</b> - 3000K, CRI>90 <b>35K</b> - 3500K, CRI>90 <b>40K</b> - 4000K, CRI>90	<b>NS</b> - Narrow Spot <b>SP</b> - Spot <b>FD</b> - Flood <b>WF</b> -Wide Flood	<b>H</b> - Halo <b>J</b> - Juno <b>L</b> - Lightolier <b>G</b> - Global
Finish	Accessory			
<b>B</b> - Black <b>W</b> - White <b>S</b> - Silver	<b>HC</b> - Honeycomb Louver			



### Features

#### Light Engine:

High-performance D-COB (Driver and COB on board) LED module provides chromaticity consistency within a 3-step MacAdam Ellipse.

#### Optics:

Polycarbonate total internal reflection (TIR) lenses provide precise beam shapes with minimal glare and spill and light scallops.

#### Housing:

Electrostatically powder coated cold-forged engine grade high purity aluminum.

#### Solid State Driver:

The solid-state onboard linear driver IC eliminates the need for an electrolytic capacitor and thus increases the lifespan.

#### Mounting:

Available in "H", "J", "L" and "G" type connectors that allow for 345° rotation and 90° tilt.

### Specification

**Total lumen output max:** 1000 lm

**Delivered lumen max:** 800 lm

**Track connector:** "H"/"J"/"L"/"G"

**Power consumption:** 10.6W @ 120V

**Dimming:** TRIAC,ELV

**Power factor:** >0.9

**Input voltage:** 110V - 140V

**Approved locations:** IP20, Dry

**Lumen maintenance:** 70% @ 60,000 Hrs

**Tilt:** 90°

**Rotate:** 345°

**THD** <20%

**Certification:** cETLus

**Warranty:** 5 years limited warranty



Consult website for detail:  
[www.vvydlighting.ca/warranty](http://www.vvydlighting.ca/warranty)

# Canister Small T634

Integrated D-COB LED Track Light

## Dimensions

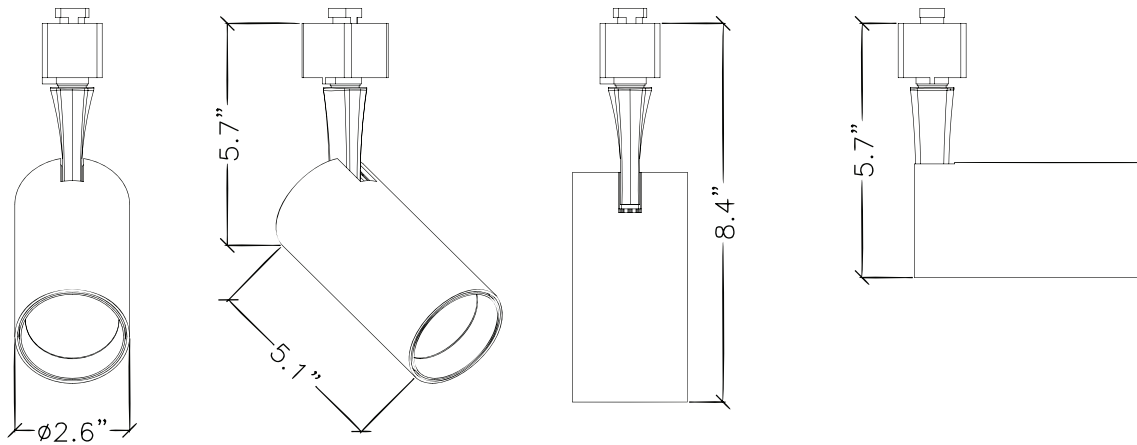

## Photometric Data for 3000K

### Narrow Spot

D (ft)	fc	702 lumens	$\varnothing$ (in)
3	202		12
6	51		21
9	22		32
12	13		43
15	8		53

Beam angle:  $19^\circ$

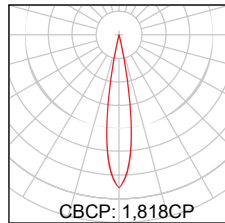

### Spot

D (ft)	fc	583 lumens	$\varnothing$ (in)
3	142		16
6	35		32
9	15		48
12	9		64
15	6		80

Beam angle:  $26^\circ$

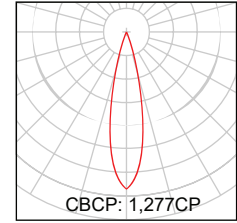

### Flood

D (ft)	fc	670 lumens	$\varnothing$ (in)
3	134		19
6	34		39
9	15		58
12	8		78
15	5		97

Beam angle:  $35^\circ$

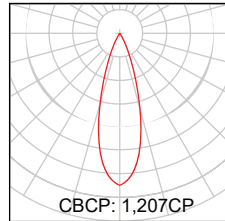

### Wide Flood

D (ft)	fc	746 lumens	$\varnothing$ (in)
3	50		37
6	13		75
9	6		112
12	3		150
15	2		187

Beam angle:  $55^\circ$

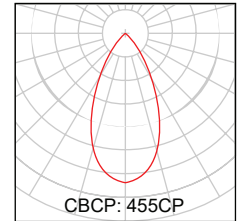

The data shown is for 3000K. Multiply FC by the following adjustment factors for other color temperatures.

Colour Temp.	2700K	3000K	3500K	4000K
Adjustment factors	0.98	1.0	1.02	1.05

## Colorimetric Data

30K, CRI>90

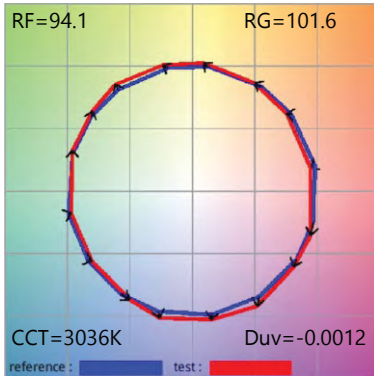

40K, CRI>90

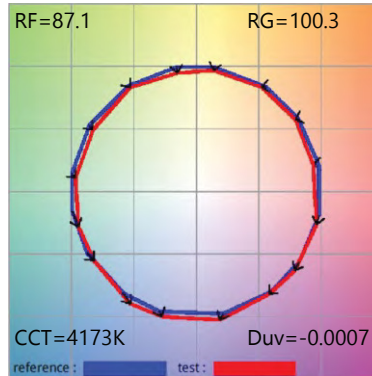

50K, CRI>90

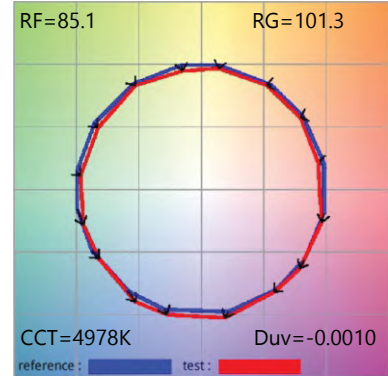

## Compatible Dimmers

Lutron®		Leviton®	Cooper®
S-603PG	SELV-300P	IPI06-1LZ	DLC03P
DVCL-153P	TG-600P	6631-2	DAL06P
DV-600P	LG-600P	VPE06	SLC03P
TGCL-153P	CT-103P	6683-IW	
S-600P	MAELV-600	6161	
DVEL-303P	FAELV-500	6633-P	

## Accessory

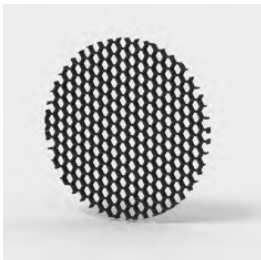

HC - Honeycomb Louver

