



# MIZAR R902

Integrated LED Lighting Fixture  
Fixed Hyperbolic Trim

## Product Description

R902 hyperbolic trim recessed LED lighting fixture minimizes glare and produces an attractive soft glow around the edge of the trim. The combination M2 high power light engine, the stylish die-cast trim and the reliable driver makes this recessed lighting fixture an ideal choice to meet all functional and aesthetic requirements of residential and commercial applications.

## Order Information

Example: R902-9-25T-VN-B-E-43HC

Model <b>R902</b>	Power	COB	Beam Angle
Integrated Recessed LED Engine Fixture	9 - 9W 12 - 12W	<b>25T</b> - 2500K, CRI>95 <b>27T</b> - 2700K, CRI>95 <b>30T</b> - 3000K, CRI>95 <b>35T</b> - 3500K, CRI>95 <b>30C</b> - 3000K, CRI>90 <b>40C</b> - 4000K, CRI>90 <b>DW</b> - Dim to Warm 2200K-3000K	<b>VN</b> - Very Narrow Spot <b>NS</b> - Narrow Spot <b>SP</b> - Spot <b>FD</b> - Flood <b>WF</b> - Wide Flood
Trim Color	Dimming	Accessories	
<b>B</b> - Black <b>W</b> - White	<b>E</b> - ELV/Triac Dimming <b>V</b> - 0-10V Dimming	<b>43HC</b> - 43mm. honeycomb louvre <b>RP</b> - Rough-in Plate	

\* 9° is available only in 9W

Project Name :
Location :
Quantity :
Date :
Note :



## Features

### LED Light Source:

Available in a wide range of colour temperatures with high color fidelity and gamut to bring out vivid colors.

**Optics:** TIR lens collimate light into precisely controlled beam shapes ranging from 13° narrow spot to 60° wide flood.

### Driver:

Flicker free TRIAC or 0-10V silicon filled driver for maximum lifespan.

### Heat Sink:

Cold forged engine grade pin fin aluminum heat sink provides optimal heat Management in a small package.

## Specification

**CCT:** 2500K/2700K/3000K/3500K/4000K  
**CRI:** >90 / >95  
**Tilt:** None, Fixed  
**Dimming:** ELV/0-10V Dimming  
**Total lumen output max:** 1300 lm @ 12W  
**Delivered lumen max:** 937 lm @ 12W  
**Power consumption:** 9W / 12W  
**Power factor:** >0.9  
**Power Driver Type:** Constant Current  
**Input voltage:** 120V, 60Hz  
**Approved locations:** IP20, Dry  
**Lumen maintenance:** 70% @ 60,000 Hrs  
**THD** <20%  
**Certification:** cETLus  
**Warranty:** 5 years limited warranty

## Dimensions

**Cut Out:** 3 inch  
**Outer Diameter:** 3.3 inch  
**Ceiling Clearance Required:** 4.6 inch



Consult website for detail:  
[www.vyvydlighting.ca/warranty](http://www.vyvydlighting.ca/warranty)

# R902 Integrated LED Recessed Light

## Dimensions

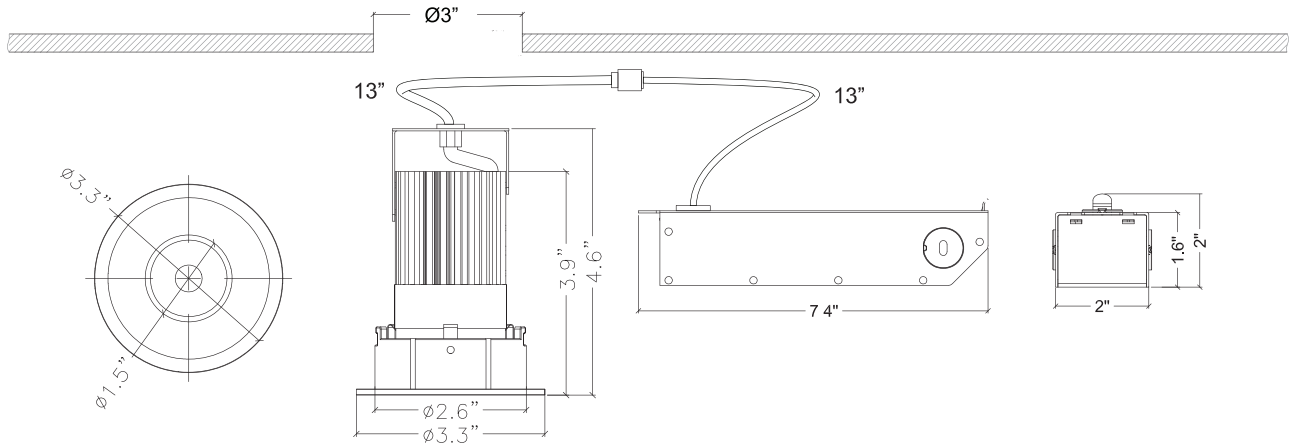

## Colorimetric Data (TM30-15)

**Realist Series:** Full gamut light source that mimics the colour rendering property of halogen lamps.

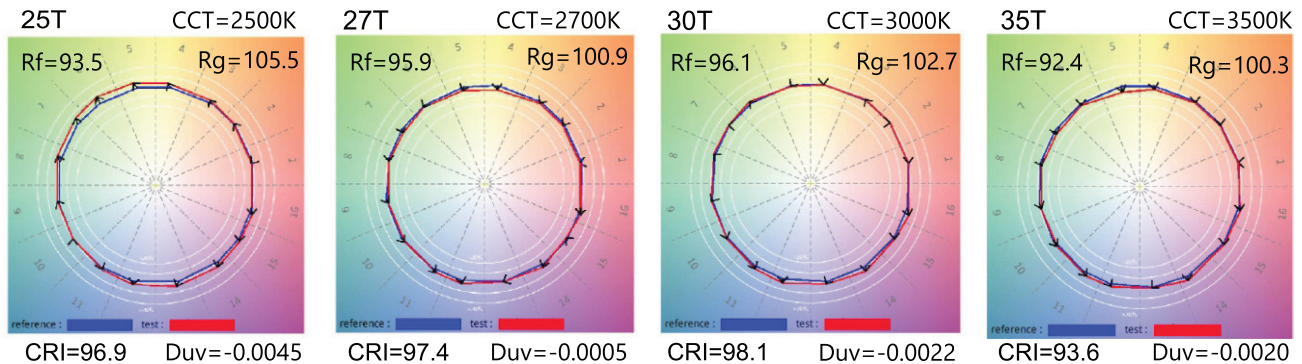

**Impressionist Series:** Colour enhancing light source that renders over-saturated colours

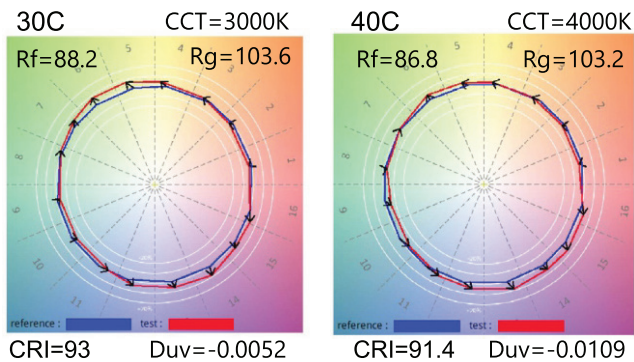

# R902 Integrated LED Recessed Light

## Photometric Data

### 9W

#### 9W VN-Very Narrow Spot, FWHM<sup>2</sup>=9°

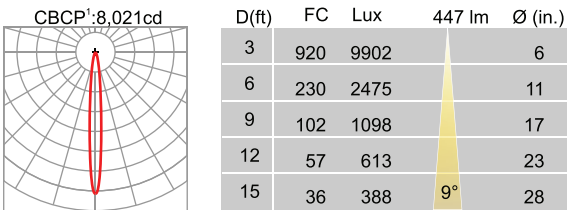

#### 9W SP-Spot, FWHM<sup>2</sup>=20°

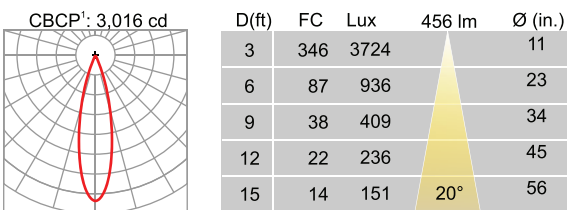

#### 9W WF-Wide Flood, FWHM<sup>2</sup>=56°

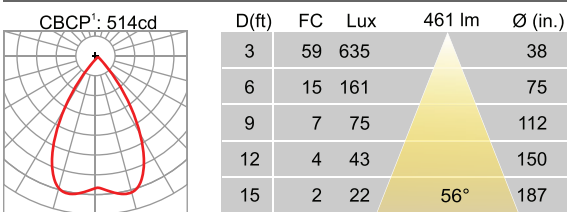

### 12W

#### 12W NS- Narrow Spot, FWHM<sup>2</sup>=13°

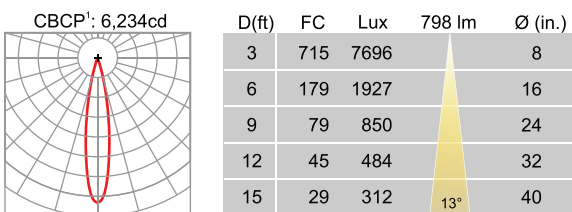

#### 12W FD-Flood, FWHM<sup>2</sup>=43°

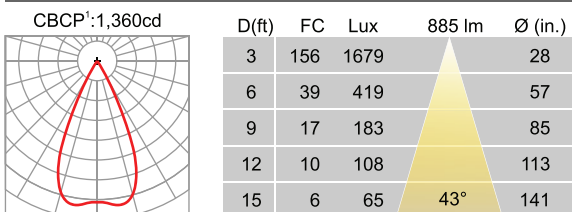

Data shown is measured for 30C light source. Multiply CBCP, FC and Lux by the following adjustment factors for other light sources

Light Source	25C	27T	30T	35T	30C	40C
Adjustment factors	0.88	0.92	0.98	1.02	1.00	1.05

#### 9W NS-Narrow Spot, FWHM<sup>2</sup>=13°

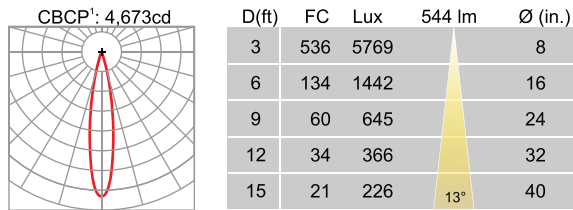

#### 9W FD-Flood, FWHM<sup>2</sup>=43°

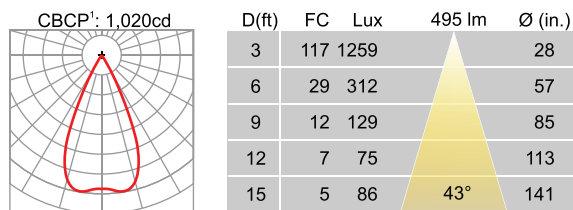

#### 12W SP- Spot, FWHM<sup>2</sup>=20°

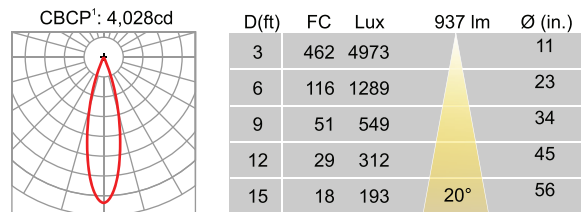

#### 12W WF-Wide Flood, FWHM<sup>2</sup>=56°

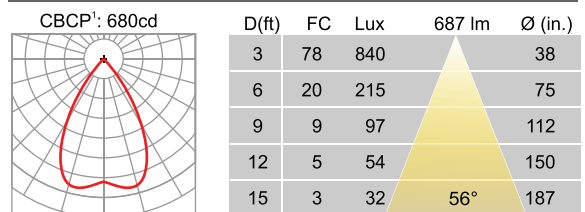

<sup>1</sup> CBCP: Centre Beam Candlepower

<sup>2</sup> FWHM: Full Width Half Maxium Angle